

Service Document **Exchange Set**

MP520/256MB

Service Manual
Sicherheit Safety
Materialnr./Part No. 720108000001



Es gelten die Vorschriften und Sicherheitshinweise gemäß dem Service Manual "Sicherheit", Materialnummer 720108000001, sowie zusätzlich die eventuell abweichenden, landesspezifischen Vorschriften!



The regulations and safety instructions shall be valid as provided by the "Safety" Service Manual, part number 720108000001, as well as the respective national deviations.

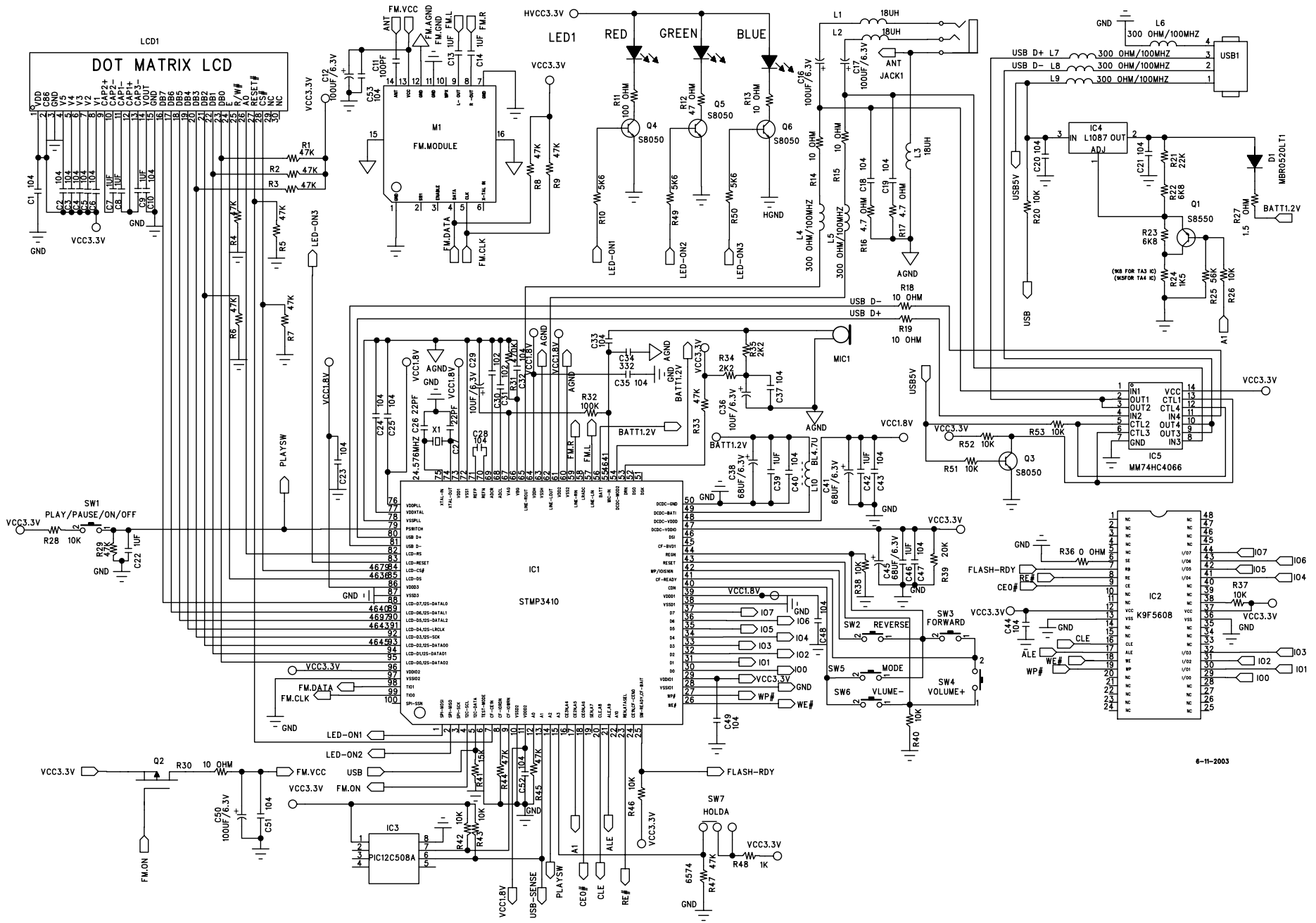

6-11-2003

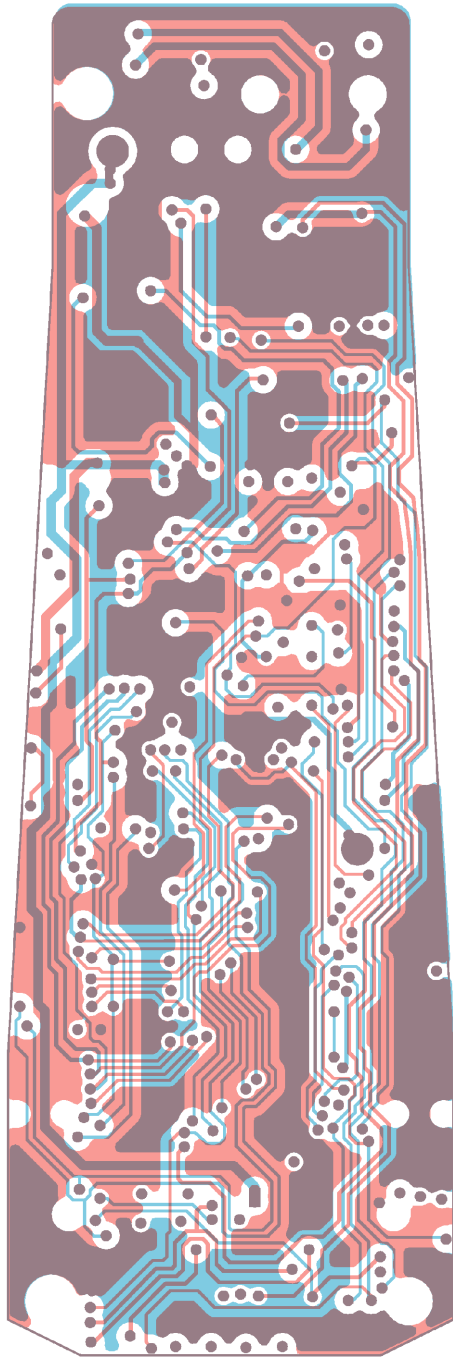

Layer 2 + 3

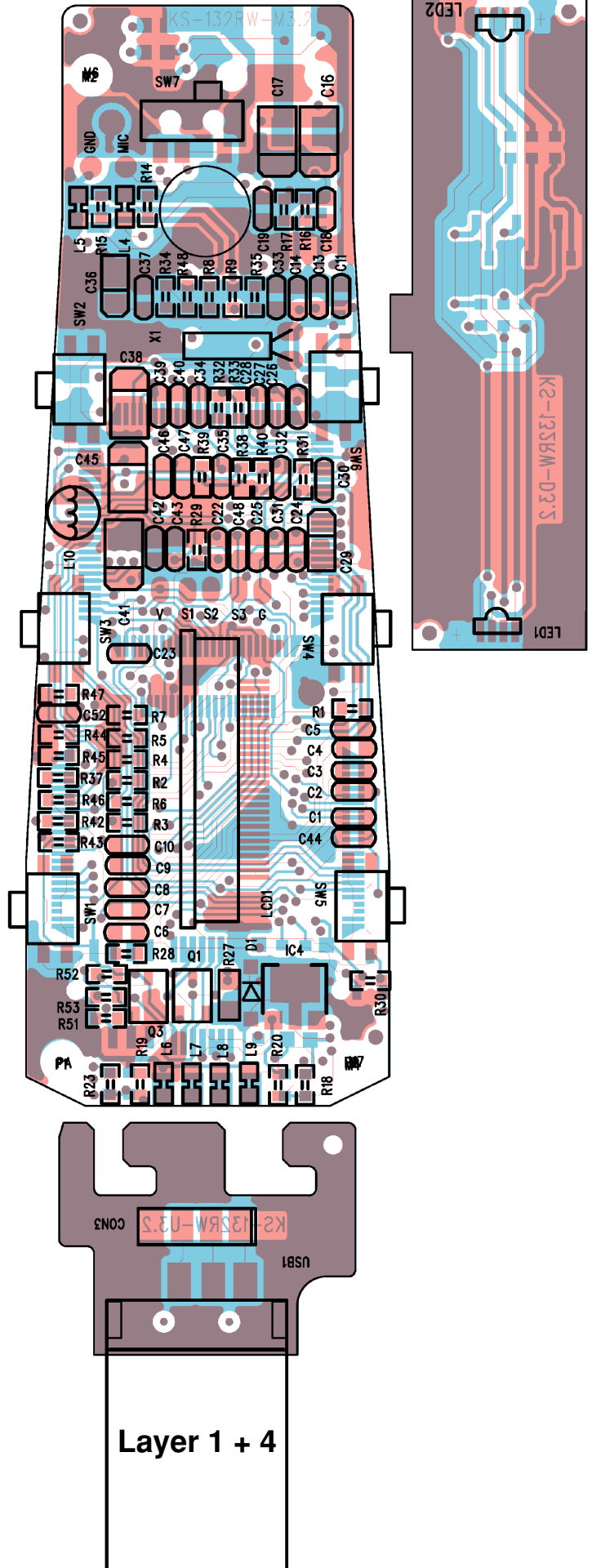

Layer 1 + 4

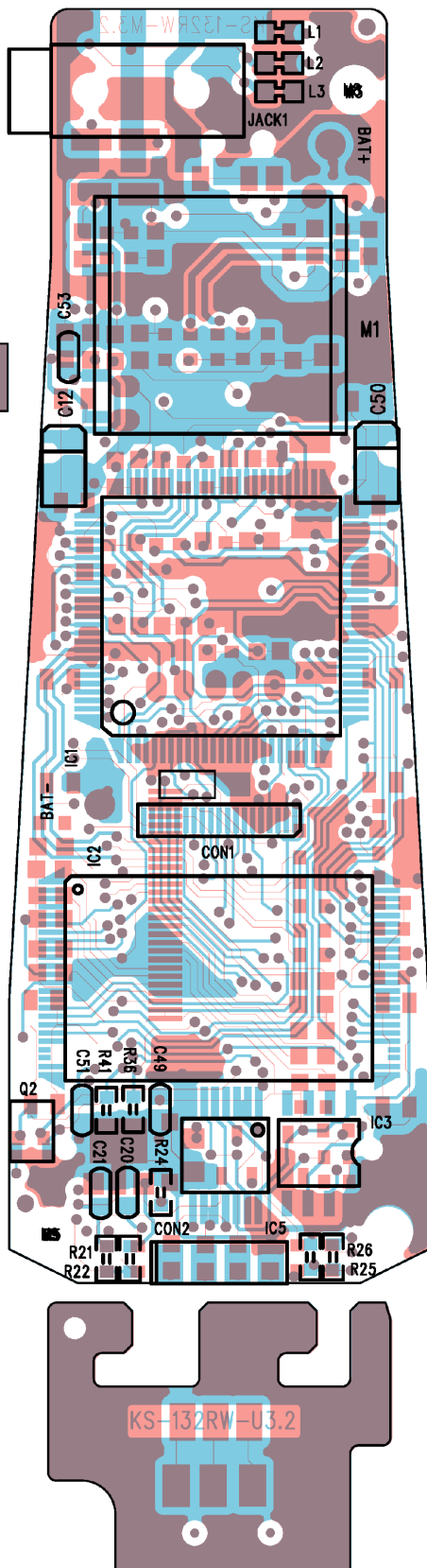
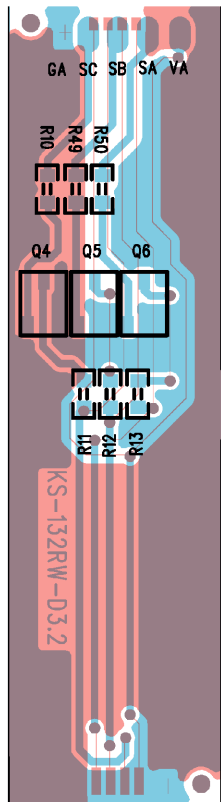

Layer 1 + 4

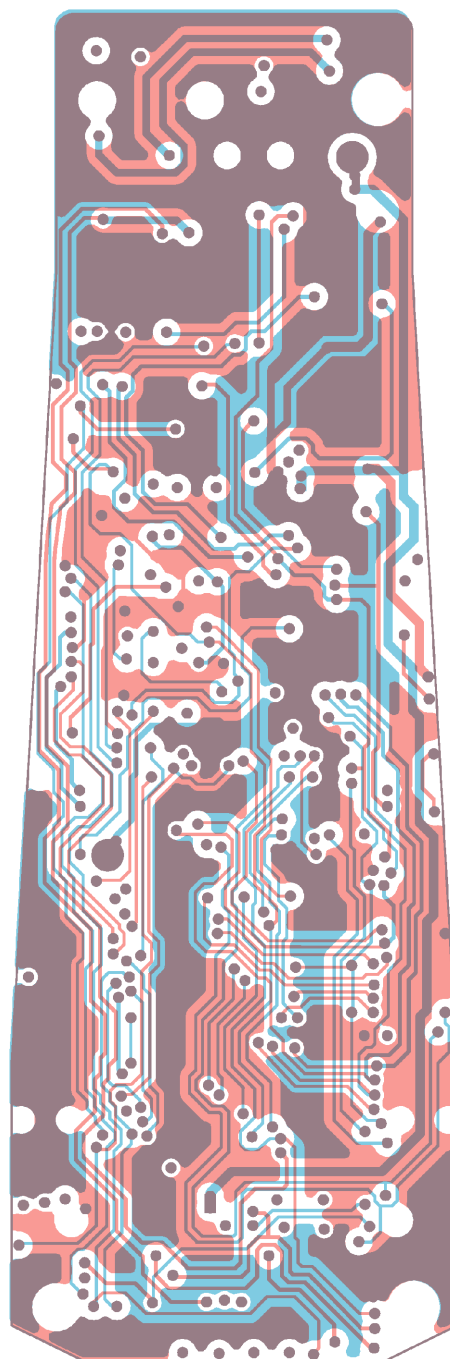

Layer 2 + 3

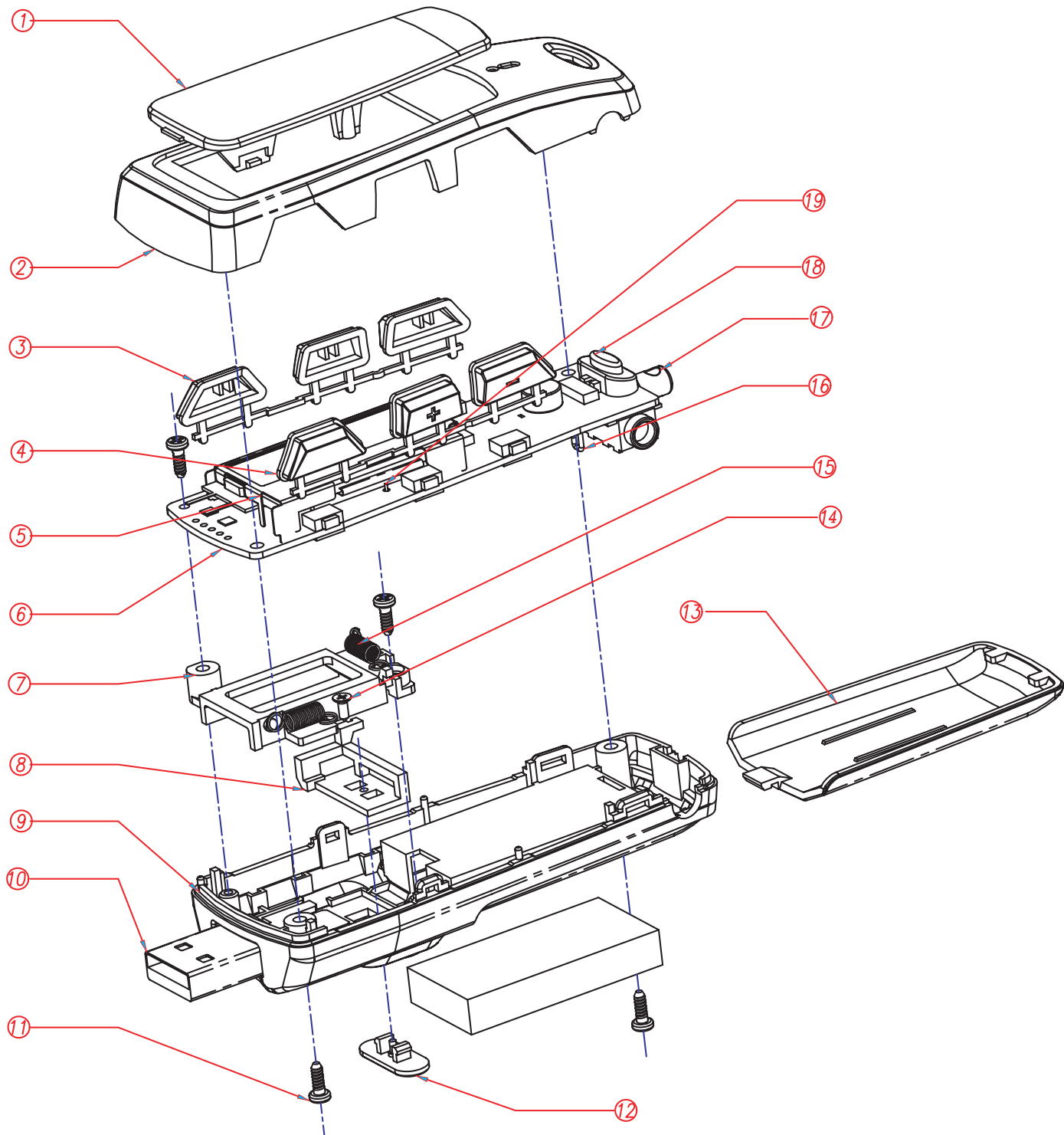



Ersatzteilliste Spare Parts List

AUDIO

12 / 2004

MP 520/256 PACK

MATERIAL-NR. / PART NO.: 720118742200
BESTELL-NR. / ORDER NO.: GDP9000 BLACK

POS. NR. POS. NO.	ABB. FIG.	MATERIAL-NR. PART NUMBER	ANZ. QTY.	BEZEICHNUNG 	DESCRIPTION 
		720118742200		MP 520/256 PACK BLACK TAUSCHGERAET	MP 520/256 PACK BLACK EXCHANGE SET
0004.000		759551096500		USB-BUCHSENABDECKUNG SCHWARZ	USB COVER BLACK
0013.100		759551096100		AKKUFACHABDECKUNG SCHWARZ	ACCU DOOR BLACK
0013.200		759551096300		BATTERIEFACHABDECKUNG SCHWARZ	BATTERY DOOR BLACK
0100.000		759551096600		NICKEL METAL HYDRIDE ACCU 1.2V	NICKEL METAL HYDRIDE ACCU 1.2V
0200.000		759551096700		STECKERNETZTEIL 6V- 0.5A	ADAPTER POWER SUPPLY
		720114050000		BEDIENUNGSANLEITUNG D/GB/F	INSTRUCTION MANUAL D/GB/F

Es gelten die Vorschriften und Sicherheitshinweise gemäß dem Service Manual "Sicherheit", Mat.-Nummer 720108000001, sowie zusätzlich die eventuell abweichenden, landesspezifischen Vorschriften!



The regulations and safety instructions shall be valid as provided by the "Safety" Service Manual, part number 720108000001, as well as the respective national deviations.

ÄNDERUNGEN VORBEHALTEN / SUBJECT TO ALTERATION